

B2YBR0157

Small Style Inground Light

1. Exterior details

1.1 Luminaire

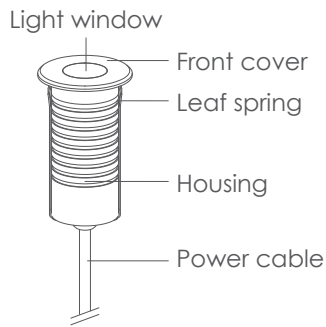

1.2 Dimension (mm)

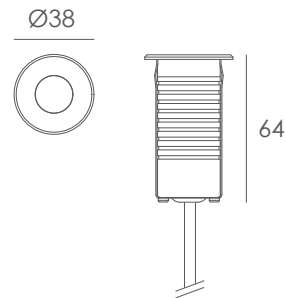

1.3 Recessed sleeve (Optional)

A04#

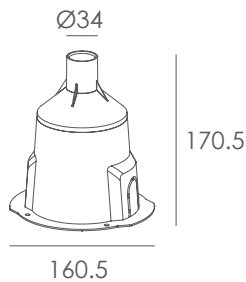

183#

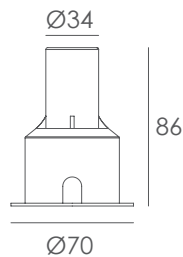

2. Datasheet

Housing:	6063# powder coated aluminum T=60-80µm Adhesion of ISO class 1/ASTM class 4B
Front Cover:	316# stainless steel forged molding with hard chromeplated
Light Window:	Tempered step glass.T=4mm
Gasket:	Silicon rubber molding shaped seal
Cable Gland:	IP67 Nickel coated copper
LED Driver:	Constant Current Input
Glass Pressure Capacity:	1,868kgs
Operating Temperature:	-20°C~40°C
Power Cable:	H05RN-F 2×1.0mm ² , L=0.5m

Light Source:	1×1.5W
Beam Angle:	15°
Input Voltage(v):	DC 24
Operating Current(mA):	88
Consumption(w):	2.1
Luminance(lm):	145
IK:	03

3. Installation steps

Step 1

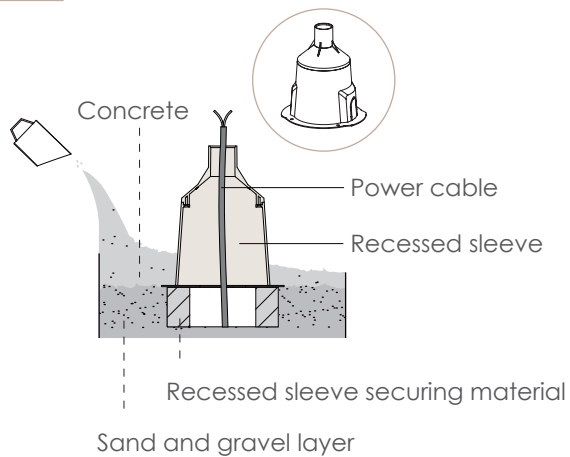

Step 2

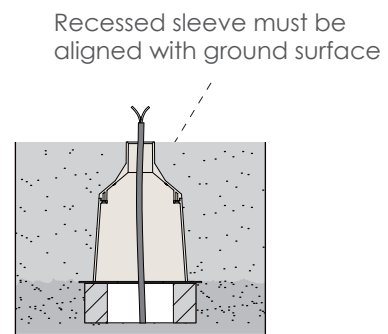

Step 3

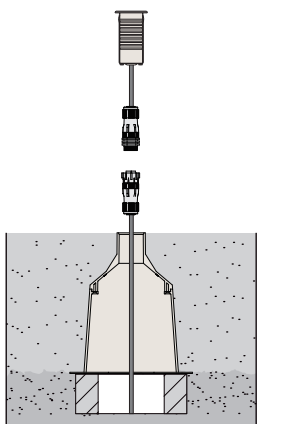

Connect the power cable

Step 4

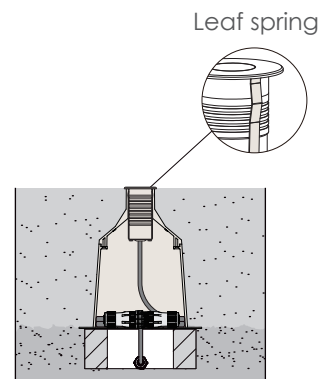

Kapego company limited

TEL:+86 076983997830
 Email:sales@kapego.com
 Website:www.kapego.com
 East changle Road, Yuning industrial district.
 Hengli, Dongguang, guangdong, China 523478

